

VENTILE REIHE 70, PNEUMATISCH

TECHNISCHE DATEN	1/8"	1/4"	1/2"
Arbeitsdruckbereich	Vakuum bis 10 bar		
Minimaler Arbeitsdruck			
• monostabil	2.5 bar		
• bistabil	1 bar		
Arbeitstemperaturbereich	-10° bis 60°C		
Nenndurchmesser	5 mm	7.5 mm	15 mm
Durchflussleistung C [NI/min · bar]	121.43	264.26	971.43
Kritischer Faktor b	0.32 bar/bar	0.27 bar/bar	0.43 bar/bar
Durchfluss bei 6 bar ΔP 0.5 bar	400 NI/min	750 NI/min	3200 NI/min
Durchfluss bei 6 bar ΔP 1 bar	550 NI/min	1100 NI/min	4600 NI/min
TRA/TRR monostabil bei 6 bar	6ms/15ms	7ms/15ms	16ms/46ms
TRA/TRR bistabil bei 6 bar	7ms/7ms	7ms/7ms	16ms/16ms

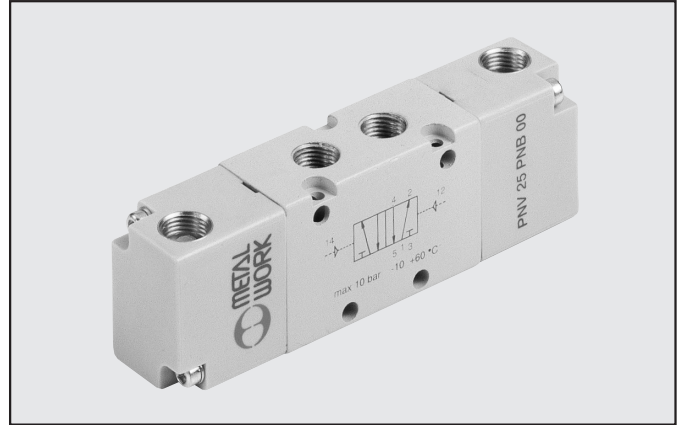

TYPENSCHLÜSSEL

P	N	V	2	3	P	N	S	N	C			
FAMILIE			ANSCHLUSS		FUNKTION		BETÄTIGUNG 14		RÜCKSTELLUNG 12		WEITERE DETAILS	
PNV pneumatische Ventile			2 1/8"	3 3/2	PN pneumatisch		S mechanische Feder	OO 5/2		NC normal geschlossen		
			3 1/4"	5 5/2			B bistabil	NO normal offen		CC Zentrum geschlossen		
			4 1/2"	6 5/3			D Differentialkolben	OC Zentrum entlüftet		PC Zentrum belüftet		
							O Mittelstellung 5/3					
							AA pneumatisch/mechan. Feder*					
							*auf Anfrage					

VENTILE REIHE 70, PNEUMATISCH, 1/8"

MONOSTABIL 3/2 NO, 1/8"

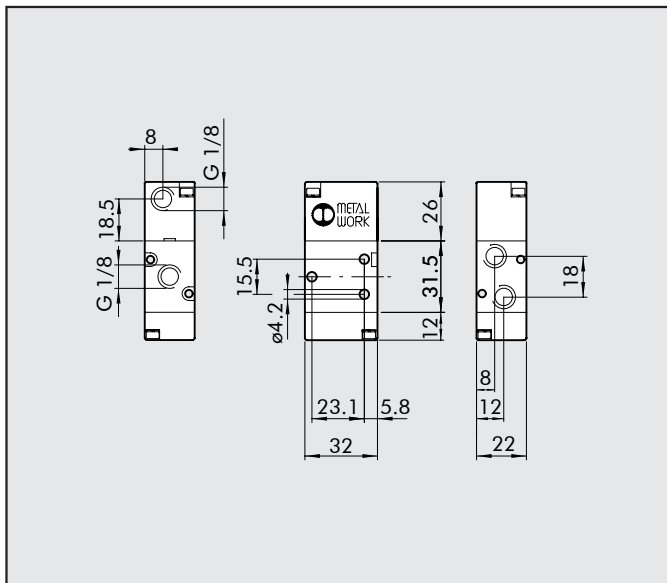

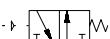
Symbol	Typ	Bestellnummer	Gewicht [g]
	PNV 23 PNS NO	7010010400	82

MONOSTABIL 3/2 NC, 1/8"

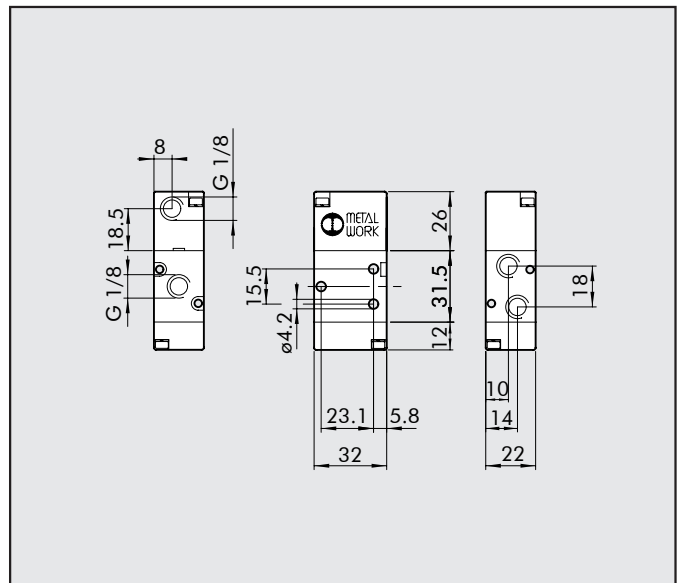

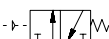
Symbol	Typ	Bestellnummer	Gewicht [g]
	PNV 23 PNS NC	7010010200	82



MONOSTABIL 5/2, 1/8"

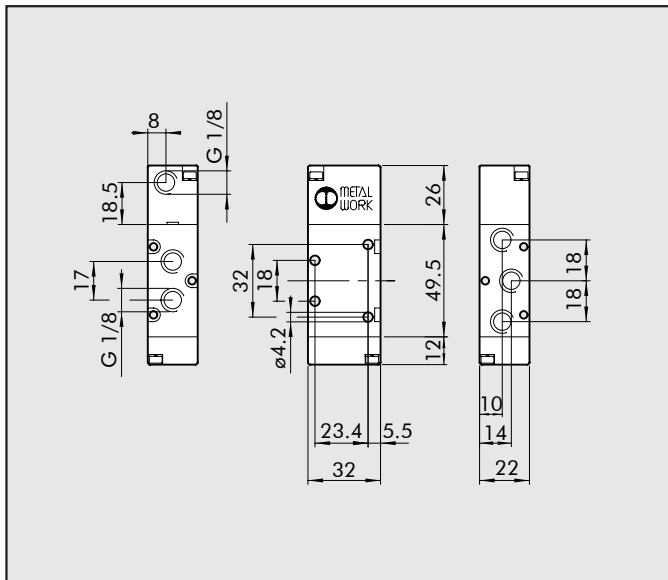

Symbol	Typ	Bestellnummer	Gewicht [g]
→	PNV 25 PNS OO	7010011100	108

BISTABIL 5/2, 1/8"

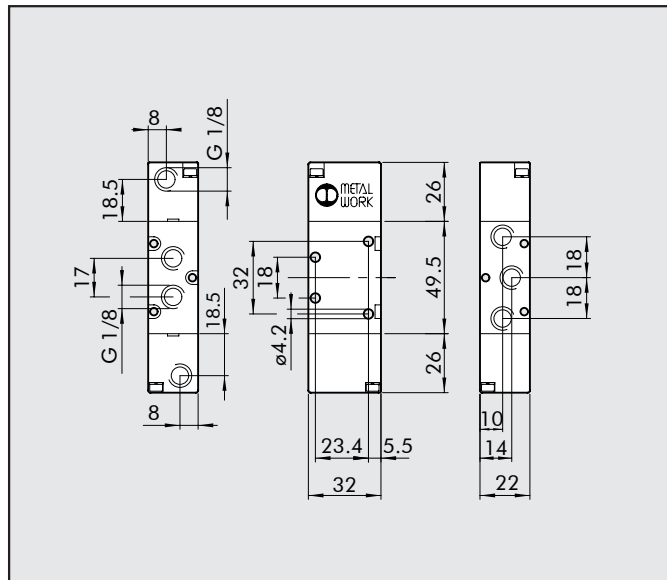

Symbol	Typ	Bestellnummer	Gewicht [g]
→ ←	PNV 25 PNB OO	7010011200	122
↔ ←	PNV 25 PND OO	7010011300	128

BISTABIL 3/2, 1/8"

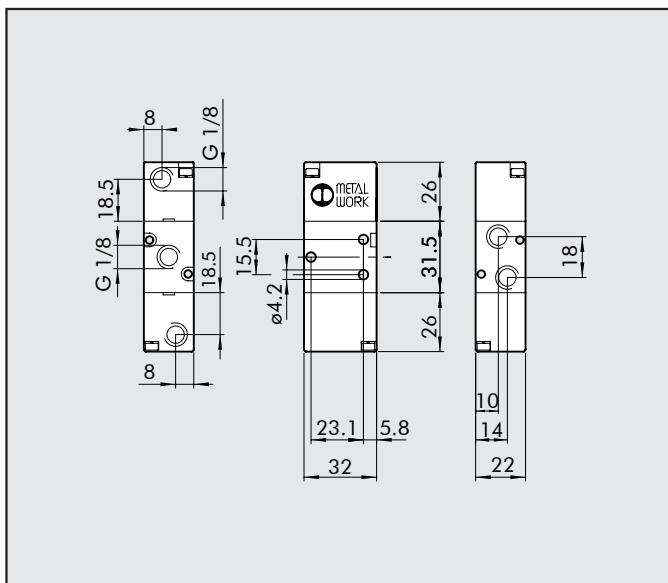

Symbol	Typ	Bestellnummer	Gewicht [g]
→ ←	PNV 23 PNB OO	7010010100	96

MITTELSTELLUNGS-VENTIL 5/3, 1/8"

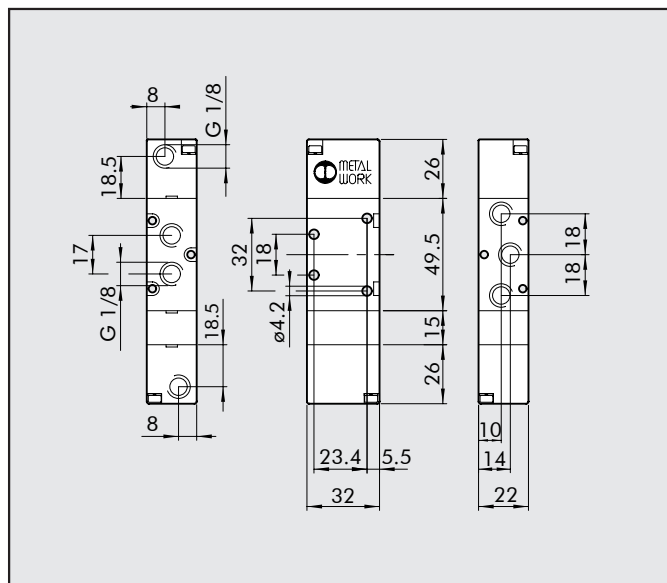

Symbol	Typ	Bestellnummer	Gewicht [g]
↔ ↔	PNV 26 PNS CC	7010012100	150
↔ ↔	PNV 26 PNS OC	7010012200	150
↔ ↔	PNV 26 PNS PC	7010012300	150

VENTILE REIHE 70, PNEUMATISCH, 1/4"

MONOSTABIL 3/2 NO, 1/4"

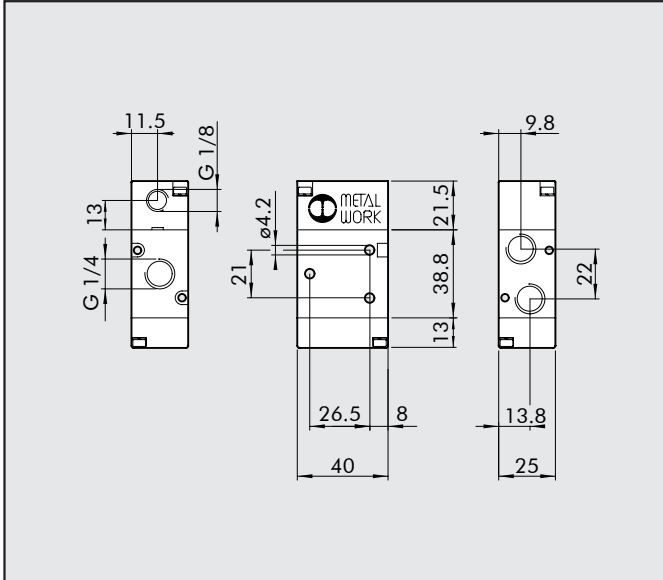

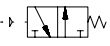
Symbol	Typ	Bestellnummer	Gewicht [g]
	PNV 33 PNS NO	7020010400	124

MONOSTABIL 3/2 NC, 1/4"

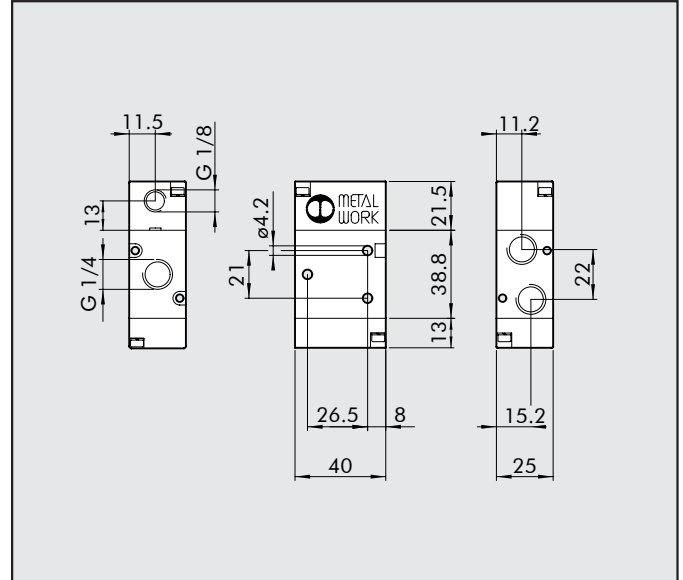

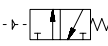
Symbol	Typ	Bestellnummer	Gewicht [g]
	PNV 33 PNS NC	7020010200	122

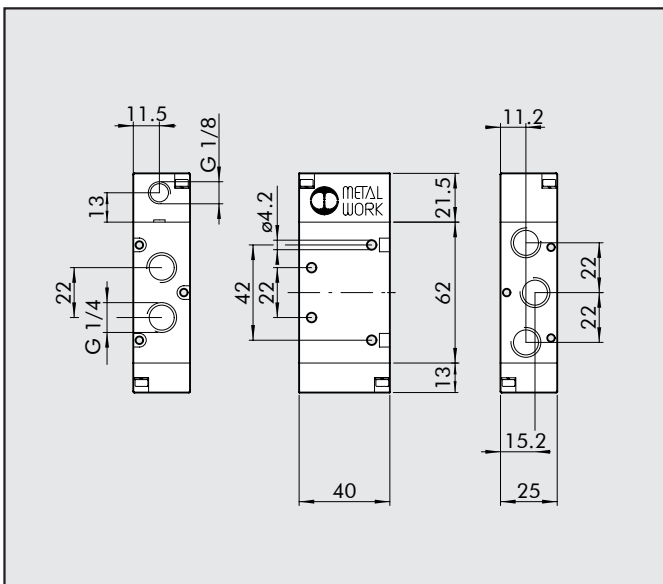

MONOSTABIL 5/2, 1/4"

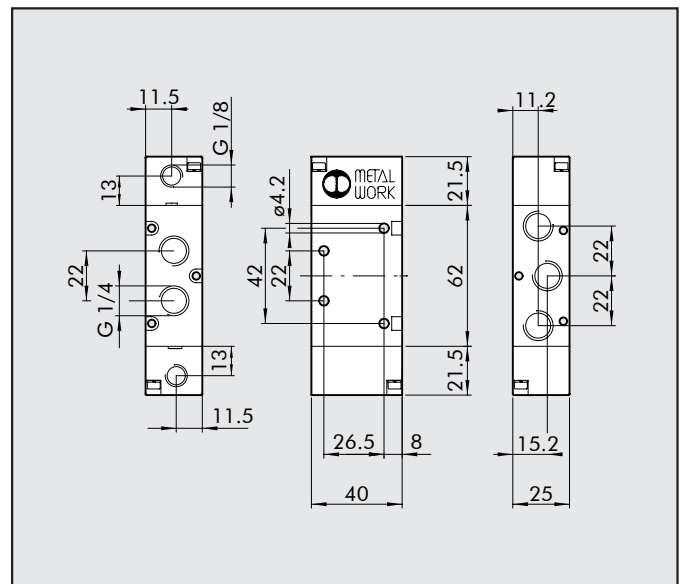

Symbol	Typ	Bestellnummer	Gewicht [g]
	PNV 35 PNS OO	7020011100	174

BISTABIL 5/2, 1/4"



Symbol	Typ	Bestellnummer	Gewicht [g]
	PNV 35 PNB OO	7020011200	174
	PNV 35 PND OO	7020011300	198

VENTILE REIHE 70, PNEUMATISCH, 1/2"

MONOSTABIL 3/2 NO, 1/2"

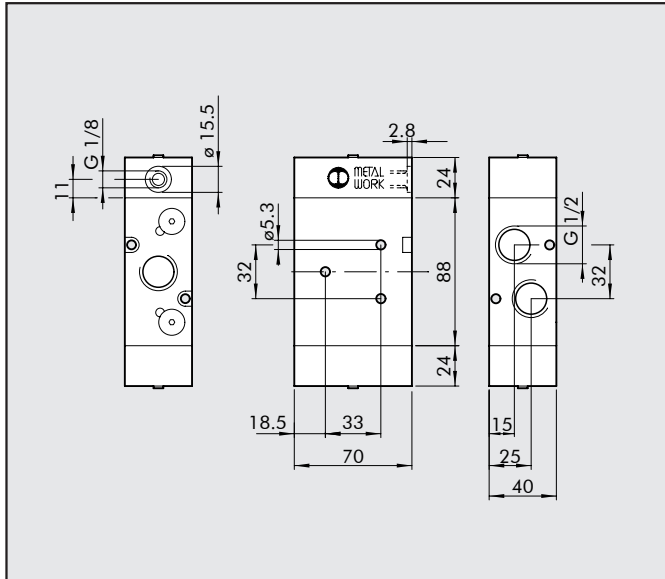

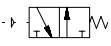
Symbol	Typ	Bestellnummer	Gewicht [g]
	PNV 43 PNS NO	7030010400	905

MONOSTABIL 3/2 NC, 1/2"

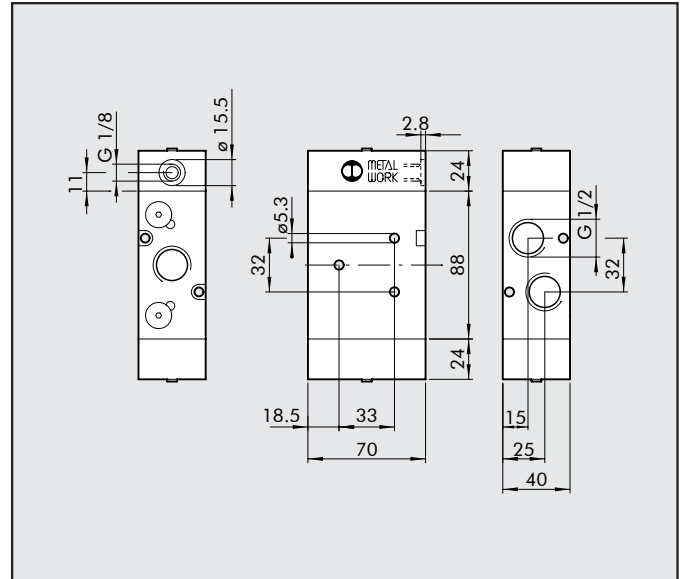

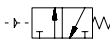
Symbol	Typ	Bestellnummer	Gewicht [g]
	PNV 43 PNS NC	7030010200	905



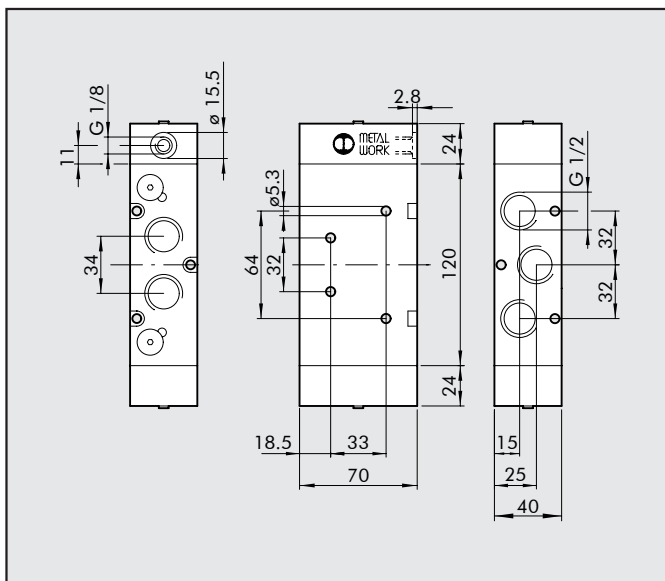

MONOSTABIL 5/2, 1/2"

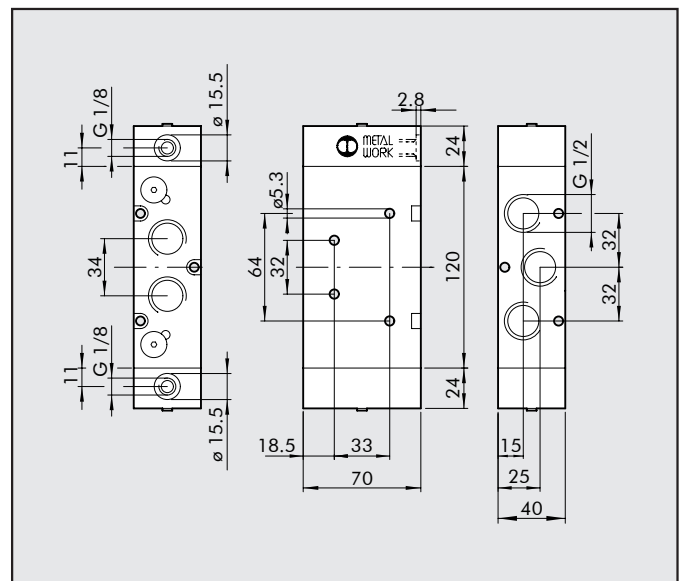

Symbol	Typ	Bestellnummer	Gewicht [g]
	PNV 45 PNS OO	7030011100	1090

BISTABIL 5/2, 1/2"



Symbol	Typ	Bestellnummer	Gewicht [g]
	PNV 45 PNB OO	7030011200	1077
			
			
	PNV 45 PND OO	7030011300	1090

