

VERSCHRAUBUNGEN Serie A

STANDARD VERSCHRAUBUNGEN

- Körper: OT58 Messing
- Maximaldruck 870 psi, 6000 kPa 60 bar



ABMESSUNGEN UND BESTELLNUMMERN

DOPPELNIPPEL-ZYLINDRISCH (A1)

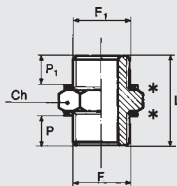

* RING D11 KANN VERWENDET WERDEN

Bestellnr.	Ref.	F	F1	Ch	P	P1	L
2101A00	A1	M5	M5	8	4.0	4.0	11.5
2101000	A1	M5	1/8	14	4.0	6.0	14.5
2101001	A1	1/8	1/8	14	6.0	6.0	17.0
2101002	A1	1/8	1/4	17	6.0	8.0	19.0
2101003	A1	1/8	3/8	20	6.0	9.0	20.0
2101004	A1	1/4	1/4	17	8.0	8.0	21.0
2101005	A1	1/4	3/8	20	8.0	9.0	22.0
2101006	A1	1/4	1/2	25	8.0	10.0	24.0
2101007	A1	3/8	3/8	20	9.0	9.0	24.0
2101008	A1	3/8	1/2	25	9.0	10.0	25.5
2101009	A1	1/2	1/2	25	10.0	10.0	26.5
2101010	A1	1/2	3/4	30	10.0	11.0	27.0
2101011	A1	3/4	3/4	30	11.0	11.0	28.0

DOPPELNIPPEL-KONISCH (A2)

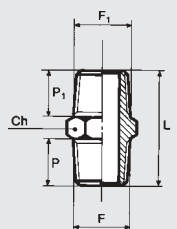

Bestellnr.	Ref.	F	F1	Ch	P	P1	L
2102001	A2	1/8	1/8	12	8.0	8.0	21.0
2102002	A2	1/8	1/4	14	8.0	11.0	24.0
2102003	A2	1/8	3/8	17	8.0	11.5	25.0
2102004	A2	1/4	1/4	14	11.0	11.0	27.0
2102005	A2	1/4	3/8	17	11.0	11.5	28.0
2102006	A2	1/4	1/2	22	11.0	14.0	32.0
2102007	A2	3/8	3/8	17	11.5	11.5	29.0
2102008	A2	3/8	1/2	22	11.5	14.0	32.5
2102009	A2	1/2	1/2	22	14.0	14.0	35.0
2102010	A2	1/2	3/4	27	14.0	16.5	37.5
2102011	A2	3/4	3/4	27	16.5	16.5	40.0

MUFFE (A3)

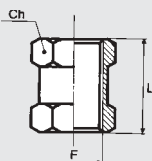

Bestellnr.	Ref.	F	Ch	L
2103000	A3	M5	8	11.0
2103001	A3	1/8	14	15.0
2103002	A3	1/4	17	22.0
2103003	A3	3/8	22	24.0
2103004	A3	1/2	27	30.0



REDUZIERNIPPEL (A4)

Bestellnr. Ref. F F1 Ch P P1 L

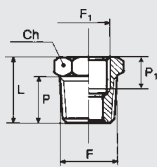

2104001	A4	1/4	1/8	14	11.0	7.0	16.0
2104002	A4	3/8	1/8	17	11.5	7.0	17.0
2104003	A4	3/8	1/4	17	11.5	8.0	17.0
2104004	A4	1/2	1/4	22	14.0	8.0	20.0
2104005	A4	1/2	3/8	22	14.0	10.0	20.0
2104006	A4	3/4	1/2	27	16.5	11.0	23.5

REDUZIERNIPPEL (A4/Z)

Bestellnr. Ref. F F1 Ch P L

* RING D11
KANN
VERWENDET
WERDEN

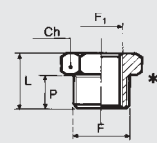

2151000	A4/Z	1/8	M5	14	6.0	10.0	
2151001	A4/Z	1/4	1/8	17	8.0	13.0	
2151002	A4/Z	3/8	1/8	20	9.0	14.0	
2151003	A4/Z	3/8	1/4	20	9.0	14.0	
2151004	A4/Z	1/2	1/4	25	10.0	15.5	
2151005	A4/Z	1/2	3/8	25	10.0	15.5	

REDUZIERSTUTZEN (A5)

Bestellnr. Ref. F F1 Ch P P1 L

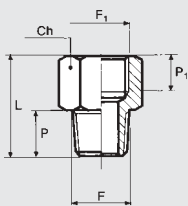

2105001	A5	1/8	1/8	14	8.0	7.0	20.0
2105002	A5	1/8	1/4	17	8.0	8.0	22.5
2105003	A5	1/4	1/4	17	11.0	8.0	25.0
2105004	A5	1/4	3/8	22	11.0	10.0	28.5
2105005	A5	3/8	3/8	22	11.5	10.0	28.5
2105006	A5	3/8	1/2	24	11.5	11.0	32.0
2105007	A5	1/2	1/2	24	14.0	11.0	34.0

REDUZIERSTUTZEN (A5/Z)

Bestellnr. Ref. F F1 Ch P P1 L

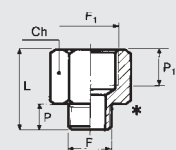

* RING D11 KANN VERWENDET WERDEN

2152001	A5/Z	M5	1/8	12	4.0	7.0	17.0
2152002	A5/Z	1/8	1/8	14	6.0	7.0	18.5
2152003	A5/Z	1/8	1/4	17	6.0	8.0	21.5
2152004	A5/Z	1/4	1/4	17	8.0	8.0	22.5
2152005	A5/Z	1/4	3/8	22	8.0	10.0	26.0
2152006	A5/Z	3/8	3/8	22	9.0	10.0	26.5
2152007	A5/Z	3/8	1/2	24	9.0	11.0	29.5
2152008	A5/Z	1/2	1/2	25	10.0	11.0	29.5

REDUZIERSTUTZEN (A6)

Bestellnr. Ref. F F1 Ch P P1 L

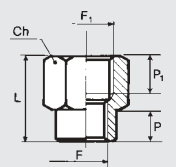

2106001	A6	1/8	1/4	17	8.0	8.0	21.5
2106002	A6	1/8	3/8	22	7.0	10.0	23.5
2106003	A6	1/4	3/8	22	9.0	10.0	25.5
2106004	A6	1/4	1/2	24	9.0	11.0	28.5
2106005	A6	3/8	1/2	24	11.0	11.0	29.5

VERSCHLUSSSTOPFEN (A7)

Bestellnr. Ref. F Ch P L E O ring

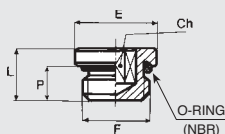

2107000	A7	M5	2.5	4.0	6.5	8	3.5x1.2
2107001	A7	1/8	3	7.0	9.5	15	2031
2107002	A7	1/4	6	8.0	11.0	18	2043
2107003	A7	3/8	8	9.0	12.5	21	2056
2107004	A7	1/2	10	11.0	14.5	26	3068

VERSCHLUSSMUTTER (A8)

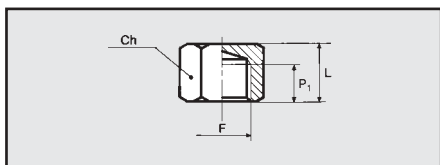

Bestellnr.	Ref.	F	Ch	P1	L
2108001	A8	1/8	14	7.0	13.0
2108002	A8	1/4	17	8.0	15.0
2108003	A8	3/8	20	10.0	17.5
2108004	A8	1/2	24	11.0	20.0

WINKELSTUTZEN (A9)

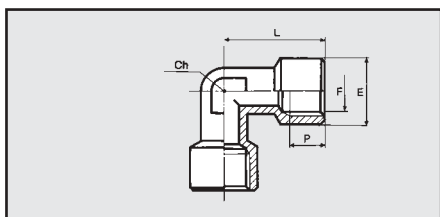

Bestellnr.	Ref.	F	Ch	P	L	E
2109001	A9	1/8	10	7.0	20.5	13.5
2109002	A9	1/4	13	8.0	26.0	17.0
2109003	A9	3/8	15	10.0	30.0	20.5
2109004	A9	1/2	20	11.0	36.0	25.5

WINKELSTUTZEN (A10)

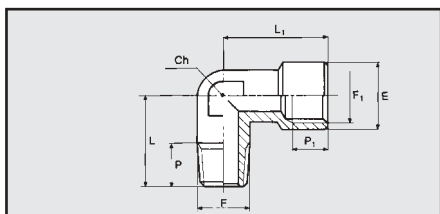

Bestellnr.	Ref.	F	F1	Ch	P	P1	L	L1	E
2110001	A10	1/8	1/8	10	8.0	7.0	16.5	20.5	13.5
2110002	A10	1/4	1/4	13	10.5	8.0	24.5	26.0	17.0
2110003	A10	3/8	3/8	15	11.0	10.0	26.0	30.0	20.5
2110004	A10	1/2	1/2	20	13.0	11.0	30.0	36.0	25.5

T-STUTZEN (A11)

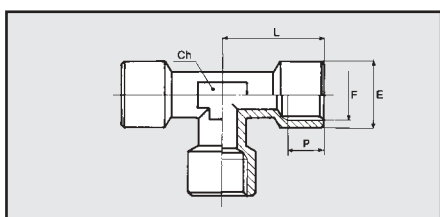

Bestellnr.	Ref.	F	Ch	P	L	E
2111001	A11	1/8	10	7.0	20.5	13.5
2111002	A11	1/4	13	8.0	26.0	17.0
2111003	A11	3/8	15	10.0	30.0	20.5
2111004	A11	1/2	20	11.0	36.0	25.5

T-STUTZEN (A12)

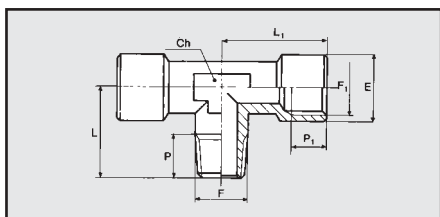

Bestellnr.	Ref.	F	F1	Ch	P	P1	L	L1	E
2112001	A12	1/8	1/8	10	8.0	7.0	16.5	20.5	13.5
2112002	A12	1/4	1/4	13	10.5	8.0	24.5	26.0	17.0
2112003	A12	3/8	3/8	15	11.0	10.0	26.0	30.0	20.5
2112004	A12	1/2	1/2	20	13.0	11.0	30.0	36.0	25.5

T-STUTZEN (A13)

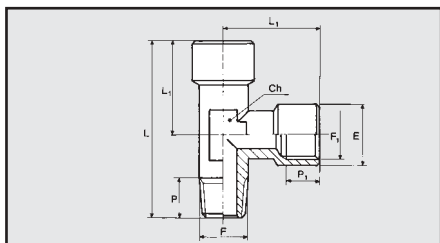

Bestellnr.	Ref.	F	F1	Ch	P	P1	L	L1	E
2113001	A13	1/8	1/8	10	8.0	7.0	37.0	20.5	13.5
2113002	A13	1/4	1/4	13	10.5	8.0	50.5	26.0	17.0
2113003	A13	3/8	3/8	15	11.0	10.0	56.0	30.0	20.5
2113004	A13	1/2	1/2	20	13.0	11.0	66.0	36.0	25.5



KREUZSTUTZEN (A14)

Bestellnr. Ref. F Ch P L E

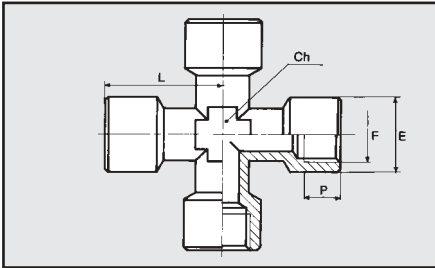

2114001	A14	1/8	10	7.0	20.5	13.5
2114002	A14	1/4	13	8.0	26.0	17.0
2114003	A14	3/8	15	10.0	28.0	20.5

WINKELSTUTZEN (A15)

Bestellnr. Ref. F Ch P L

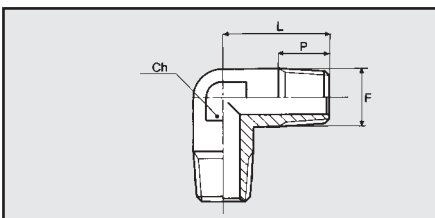

2115001	A15	1/8	10	8.0	16.5
2115002	A15	1/4	13	10.5	24.5
2115003	A15	3/8	15	11.0	26.0
2115004	A15	1/2	20	13.0	30.0

T-STUTZEN (A16)

Bestellnr. Ref. F Ch P L

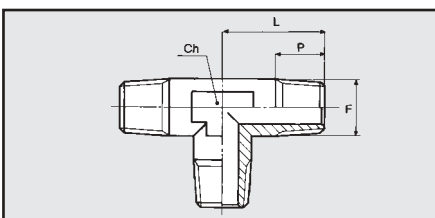

2116001	A16	1/8	10	8.0	16.5
2116002	A16	1/4	13	10.5	24.5
2116003	A16	3/8	15	11.0	26.0
2116004	A16	1/2	20	13.0	30.0

T-STUTZEN (A17)

Bestellnr. Ref. F F1 Ch P P1 L L1 E

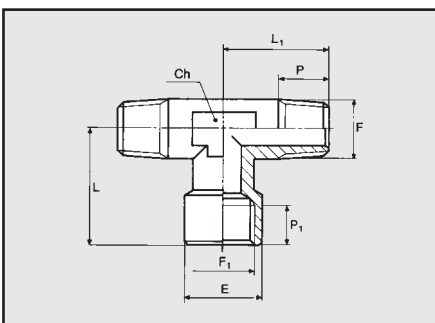

2117001	A17	1/4	1/4	13	10.5	8.0	26.0	24.5	17.0
2117002	A17	1/8	1/8	10	8.0	7.0	20.5	16.5	13.5
2117003	A17	3/8	3/8	15	11.0	10.0	30.0	26.0	20.5
2117004	A17	1/2	1/2	20	13.0	11.0	36.0	30.0	25.5

T-STUTZEN (A18)

Bestellnr. Ref. F F1 Ch P P1 L L1 E L2

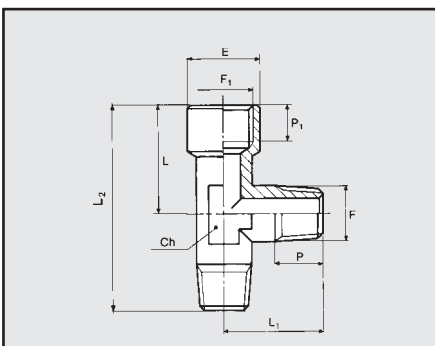

2118000	A18	1/8	1/8	10	8.0	7.0	20.5	16.5	13.5	37.0
2118001	A18	1/4	1/4	13	10.5	8.0	26.0	24.5	17.0	50.5
2118002	A18	3/8	3/8	15	11.0	10.0	30.0	26.0	20.5	56.0
2118003	A18	1/2	1/2	20	13.0	11.0	36.0	30.0	25.5	66.0

STÜCKTÜLLE (A19)

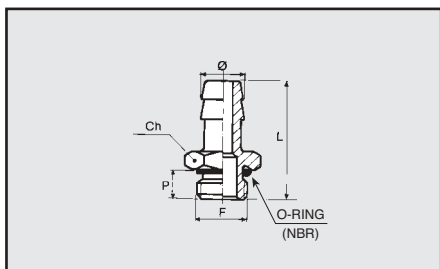

Bestellnr.	Ref.	Ø	F	Ch	P	L	O ring
2119001	A19	7	1/8	15	6.0	31.0	2031
2119002	A19	7	1/4	18	8.0	33.0	2043
2119003	A19	8	1/8	15	6.0	31.0	2031
2119004	A19	9	1/8	15	6.0	31.0	2031
2119005	A19	9	1/4	18	8.0	33.0	2043
2119006	A19	9	3/8	21	9.0	34.0	2056
2119007	A19	12	1/4	18	8.0	33.0	2043
2119008	A19	12	3/8	21	9.0	34.0	2056
2119009	A19	12	1/2	26	11.0	36.0	3068
2119010	A19	17	3/8	21	11.0	34.0	2056
2119011	A19	17	1/2	26	9.0	36.0	3068

KREUZVERTEILER (A20)

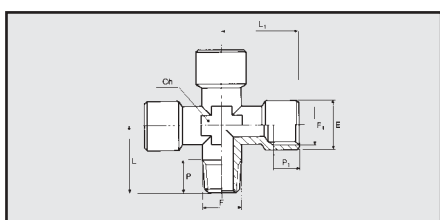

Bestellnr.	Ref.	F	F1	Ch	P	P1	L	L1	E
2120001	A20	1/8	1/8	10	8.0	7.0	16.5	20.5	13.5
2120002	A20	1/4	1/4	13	10.5	8.0	24.5	26.0	17.0

KREUZVERTEILER (A21)

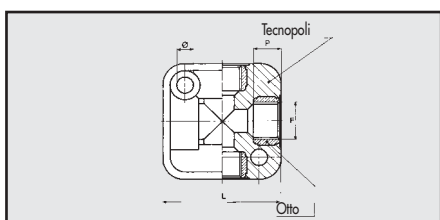

Bestellnr.	Ref.	F	Ø	P	L	spess.
2121001	A21	1/8	4.5	8.0	31.0	17.5
2121002	A21	1/4	5.5	9.0	40.0	24.0
2121003	A21	3/8	5.5	12.0	50.0	28.0
2121004	A21	1/2	5.5	12.0	50.0	34.0

Maximalwerte abweichend zur Serie A für: A21 max P 13 bar, max T 50°C

Y-VERTEILER (A23)

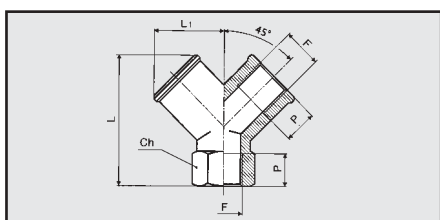

Bestellnr.	Ref.	F	Ch	P	L	L1
2123001	A23	1/8	13	8	26.5	14.5
2123002	A23	1/4	17	11	32.0	18.0
2123003	A23	3/8	20	11.5	36.5	20.5
2123004	A23	1/2	25	14	44.5	26.5

Y-VERTEILER (A24)

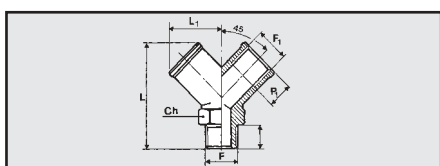

Bestellnr.	Ref.	F	F1	Ch	P	P1	L	L1
2124001	A24	1/8	1/8	13	8.0	8.0	32.0	14.5
2124002	A24	1/4	1/4	17	11.0	11.0	38.0	18.0
2124003	A24	3/8	3/8	20	11.5	11.5	42.0	20.5
2124004	A24	1/2	1/2	25	14.0	14.0	53.0	26.5

VERBINDUNGSTÜCK (A25)

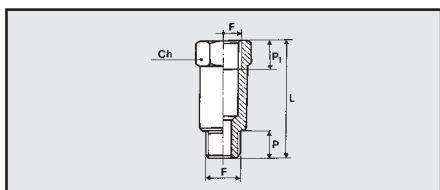

Bestellnr.	Ref.	F	Ch	P	L	P1
2150003	A25	1/8	14	6.0	22.0	8.0
2150004	A25	1/8	14	6.0	42.0	8.0
2150005	A25	1/8	14	6.0	51.0	8.0
2150006	A25	1/4	17	8.0	35.0	11.0
2150007	A25	1/4	17	8.0	51.0	11.0